

# receptiv price list

Effective January 2009

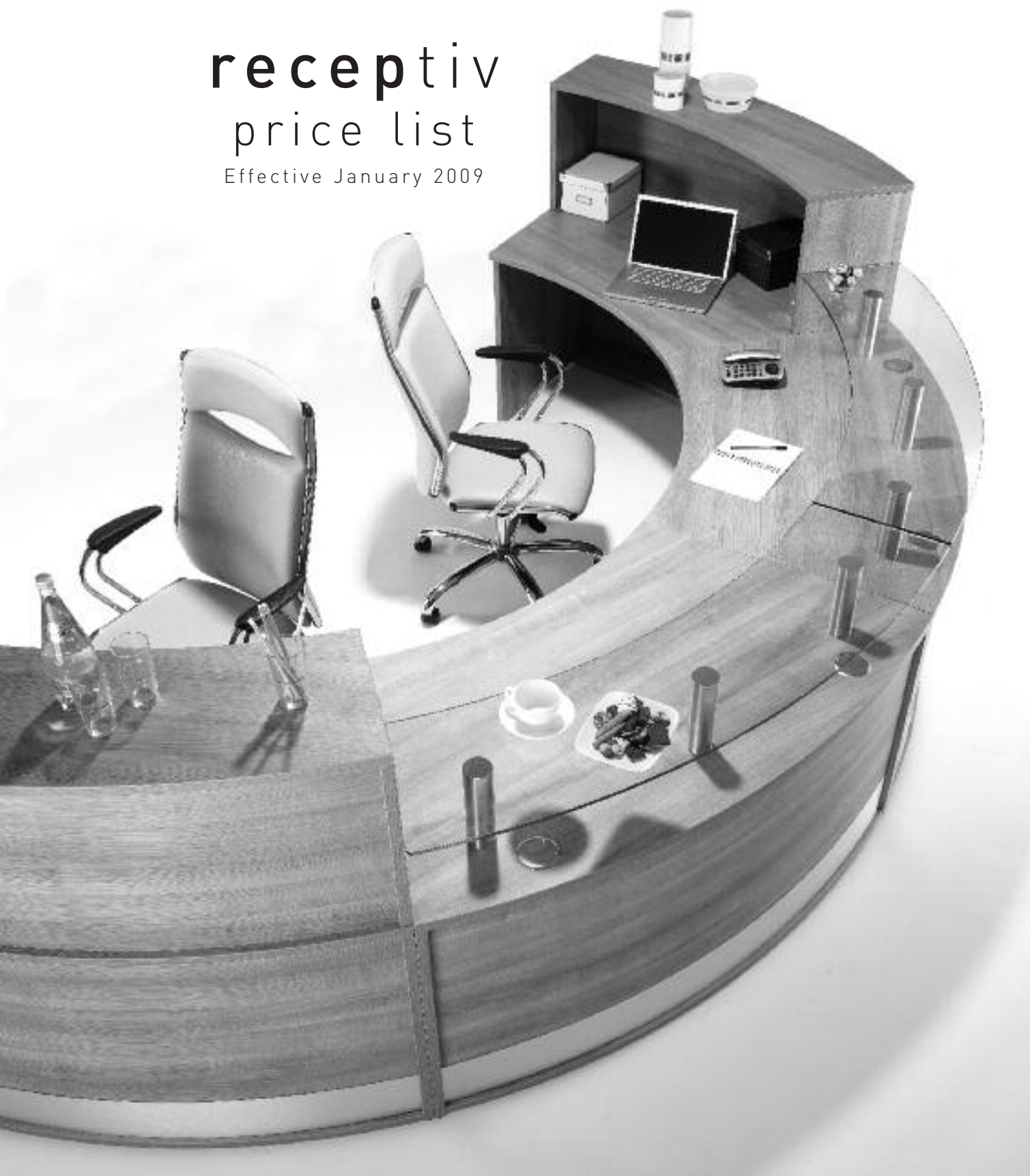

imperial

Office furniture

## Designed with flexibility in mind, offering you everything you require in a corporate office environment.

Receptiv offers a full complement of reception furniture, consisting of modular base and counter units, supplied in various sizes and finishes with accessories such as paper storage, CD racks and key lockers available as optional extras.

Low-level glass shelves on steel supports offer a more open and inviting approach to the desk. Specific modules allowing for wheelchair access, accommodating the DDA requirements are also available. A cable management facility is incorporated into desk tops and panel legs with the use of cable ports. Cable trays are also available as an additional option.

A CAD planning facility is available free of charge. Please ask for details.

### Finishes available:

#### 25mm thick melamine faced chipboard (MFC) with 2mm thick PVC edging

• Ash	J	• Canadian Maple	CM
• Apple	A	• Walnut	N
• Cherry	C	• White	W
• Beech	B	• Silver	S
• Oak	O	• Santiago Cherry	SC

#### 3mm thick MDF laminated double sided modesty panels

• Ash	J	• Silver	S
• Apple	A	• Mirror	M
• Cherry	C	• Canadian Maple	CM
• Beech	B	• Walnut	N
• Oak	O	• White	W
• Santiago Cherry	SC		

### 800 deep and 600 deep variations available

Please follow the relevant steps when ordering to avoid errors. See example shown below:

Product code: **2005.RH.JS**

Product description: Base unit supplied with one RH cut-back leg 1600 x 800 x 727 Japanese Ash c/w silver modesty panel.

Product code: **2005.RH.JS**

Individual product: **RH** = Right Hand      **J** = Wood Finishes (MFC) – Japanese Ash  
**LH** = Left Hand      **S** = Panel Finish (MDF) – Silver

Should you wish to accessorize Receptiv with pedestals, cable management trays, links and/or storage items for your reception, please refer to our **qudos** brochure and price list.

Combination of colour options available in the Receptiv range are shown below with the use of top and base units.

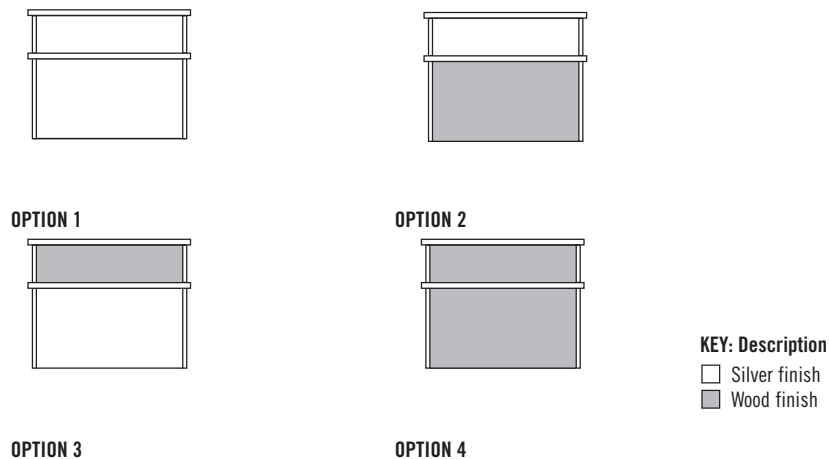

Should you decide to order a 600 deep base unit, please ensure to add (-6) to the general product code.  
 Example: **2005-6-RH-JS**

## PRODUCT CODES

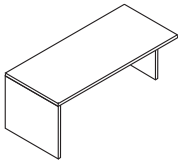

**CODE: (1)000**

**One (1)** represents individual base unit without top unit or shelves.  
(RH shown)

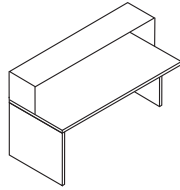

**CODE: (2)000**

**Two (2)** represents base unit to accommodate top unit.  
(RH shown)

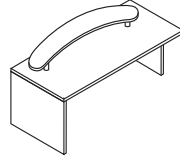

**CODE: (3)000**

**Three (3)** represents base unit to accommodate a shaped MFC or glass shelf on steel supports.  
(RH shown)

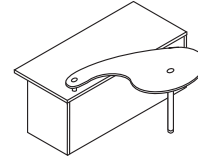

**CODE: (4)000**

**Four (4)** represents base unit 1200 (W) 1400 (W) 1600 (W) 1800 (W) to accommodate mobile rotating shelf unit.  
(RH shown)

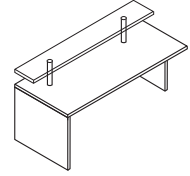

**CODE: (5)000**

**Five (5)** represents base unit to accommodate an executive glass shelf on brushed steel supports.  
(RH shown)

**1(0)00** Zero (0) represents **BASE UNITS**

**1(1)00** One (1) represents **TOP UNITS**

**1(2)00** Two (2) represents **ACCESSORIES**

**12(00)** Last two digits represents specific unit/item

**1(3)00**

**Three (3)** represents **SHAPED MFC OR GLASS SHELVES**

**1(4)00**

**Four (4)** represents **MOBILE SHELVES**

**1(5)00**

**Five (5)** represents **EXECUTIVE GLASS SHELVES**

**BASE UNITS - 1 CUT-BACK LEG**

1001(-6)	800	800(600)	727	<b>297</b>
2001(-6)	800	800(600)	727	<b>319</b>
3001(-6)	800	800(600)	727	<b>319</b>
5001(-6)	800	800(600)	727	<b>319</b>

1002(-6)	1000	800(600)	727	<b>311</b>
2002(-6)	1000	800(600)	727	<b>333</b>
3002(-6)	1000	800(600)	727	<b>333</b>
5002(-6)	1000	800(600)	727	<b>333</b>

1003(-6)	1200	800(600)	727	<b>326</b>
2003(-6)	1200	800(600)	727	<b>347</b>
3003(-6)	1200	800(600)	727	<b>347</b>
4003	1200	800	727	<b>347</b>
5003(-6)	1200	800(600)	727	<b>347</b>

1004(-6)	1400	800(600)	727	<b>339</b>
2004(-6)	1400	800(600)	727	<b>361</b>
3004(-6)	1400	800(600)	727	<b>361</b>
4004	1400	800	727	<b>361</b>
5004(-6)	1400	800(600)	727	<b>361</b>

1005(-6)	1600	800(600)	727	<b>361</b>
2005(-6)	1600	800(600)	727	<b>382</b>
3005(-6)	1600	800(600)	727	<b>382</b>
4005	1600	800	727	<b>382</b>
5005(-6)	1600	800(600)	727	<b>382</b>

1006(-6)	1800	800(600)	727	<b>382</b>
2006(-6)	1800	800(600)	727	<b>403</b>
3006(-6)	1800	800(600)	727	<b>403</b>
4006	1800	800	727	<b>403</b>
5006(-6)	1800	800(600)	727	<b>403</b>

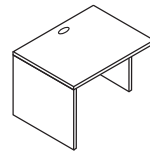

(RH shown)

Base unit supplied with one L/H or R/H cut-back leg. 800mm or 600mm deep.

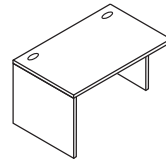

(RH shown)

Base unit supplied with one L/H or R/H cut-back leg. 800mm or 600mm deep.

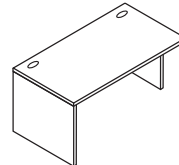

(RH shown)

Base unit supplied with one L/H or R/H cut-back leg. 800mm or 600mm deep.

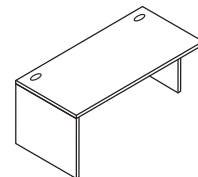

(RH shown)

Base unit supplied with one L/H or R/H cut-back leg. 800mm or 600mm deep.

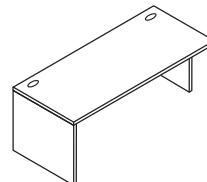

(RH shown)

Base unit supplied with one L/H or R/H cut-back leg. 800mm or 600mm deep.

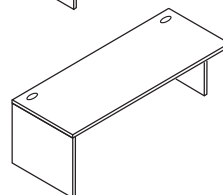

(RH shown)

Base unit supplied with one L/H or R/H cut-back leg. 800mm or 600mm deep.

## BASE UNITS - 1 CUT-BACK LEG

### CODE: (1)000

Base unit only, without top unit or shelves.

### CODE: (2)000

Base unit to accommodate top unit.

### CODE: (3)000

Base unit to accommodate a shaped MFC or glass shelf on steel supports.

### CODE: (4)000

Base unit 1200(W), 1400(W), 1600(W), and 1800(W) to accommodate mobile rotating shelf unit.

#### Description

#### Code

#### W x D x H

#### Price £

Base corner unit @ 90° with 800mm radius supplied with one LH or RH cut-back leg. (LH shown) 800mm or 600mm deep.

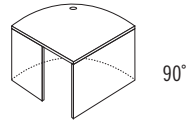

1051(-6)	800	800(600)	727	481
2051(-6)	800	800(600)	727	502
3051(-6)	800	800(600)	727	502
5051(-6)	800	800(600)	727	502

Base corner unit @ 90° with 1200mm radius supplied with one LH or RH cut-back leg. (LH shown) 800mm or 600mm deep.

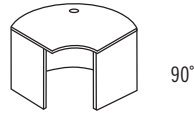

1052(-6)	1700	800(600)	727	622
2052(-6)	1700	800(600)	727	643
3052(-6)	1700	800(600)	727	643
5052(-6)	1700	800(600)	727	643

Radius base unit @ 60° with 800mm ends supplied with one LH or RH cut-back leg. (RH shown) 800mm or 600mm deep.

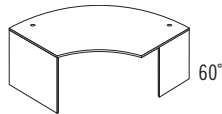

1053(-6)	1800	800(600)	727	715
2053(-6)	1800	800(600)	727	739
3053(-6)	1800	800(600)	727	739
5053(-6)	1800	800(600)	727	739

Radius base unit INVERTED @ 60° with 800mm ends supplied with one LH or RH cut-back leg. (RH shown) 800mm or 600mm deep.



1054(-6)	1800	800(600)	727	737
2054(-6)	1800	800(600)	727	762
3054(-6)	1800	800(600)	727	762
5054(-6)	1800	800(600)	727	762

Base segment unit @ 30° with 800mm ends supplied with one LH or RH cut-back leg. (LH shown) 800mm or 600mm deep.

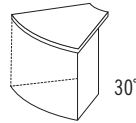

1055(-6)	880	800(600)	727	465
2055(-6)	880	800(600)	727	484

Base segment unit INVERTED @ 30° with 800mm ends supplied with one LH or RH cut-back leg. (LH shown) 800mm or 600mm deep.

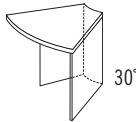

1056(-6)	880	800(600)	727	479
2056(-6)	880	800(600)	727	500

Radius base unit @ 45° with 800mm ends supplied with one LH or RH cut back leg. (RH shown) 800mm or 600mm deep.

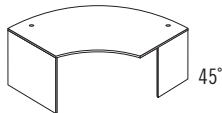

1057(-6)	1530	800(600)	727	591
2057(-6)	1530	800(600)	727	611
3057(-6)	1530	800(600)	727	611
5057(-6)	1530	800(600)	727	611

Radius base unit INVERTED @ 45° with 800mm ends supplied with one LH or RH cut back leg. (RH shown) 800mm or 600mm deep.

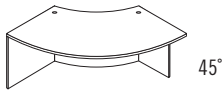

1058(-6)	1530	800(600)	727	680
2058(-6)	1530	800(600)	727	702
3058(-6)	1530	800(600)	727	702
5058(-6)	1530	800(600)	727	702

Base segment unit @ 22° with one RH or LH cut-back leg (LH shown) 800mm or 600mm deep.

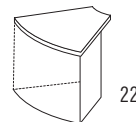

1059(-6)	780	800(600)	727	450
2059(-6)	780	800(600)	727	471

Base segment unit INVERTED @ 22° with one RH or LH cut-back leg (LH shown) 800mm or 600mm deep.

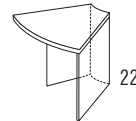

1060(-6)	780	800(600)	727	465
2060(-6)	780	800(600)	727	484

**CODE: (5)000**

Base unit to accommodate an executive glass shelf on brushed steel supports.

**BASE UNITS - 2 CUT-BACK LEGS**

Code	W	x	D	x	H	Price £	Description
1007(-6)	800	800(600)	727			297	Base unit supplied with two cut-back legs 800mm or 600mm deep.
2007(-6)	800	800(600)	727			319	
3007(-6)	800	800(600)	727			319	
5007(-6)	800	800(600)	727			319	
1008(-6)	1000	800(600)	727			311	Base unit supplied with two cut-back legs 800mm or 600mm deep.
2008(-6)	1000	800(600)	727			333	
3008(-6)	1000	800(600)	727			333	
5008(-6)	1000	800(600)	727			333	
1009(-6)	1200	800(600)	727			326	Base unit supplied with two cut-back legs 800mm or 600mm deep.
2009(-6)	1200	800(600)	727			347	
3009(-6)	1200	800(600)	727			347	
4009	1200	800	727			347	
5009(-6)	1200	800(600)	727			347	
1010(-6)	1400	800(600)	727			339	Base unit supplied with two cut-back legs 800mm or 600mm deep.
2010(-6)	1400	800(600)	727			361	
3010(-6)	1400	800(600)	727			361	
4010	1400	800	727			361	
5010(-6)	1400	800(600)	727			361	
1011(-6)	1600	800(600)	727			361	Base unit supplied with two cut-back legs 800mm or 600mm deep.
2011(-6)	1600	800(600)	727			382	
3011(-6)	1600	800(600)	727			382	
4011	1600	800	727			382	
5011(-6)	1600	800(600)	727			382	
1012(-6)	1800	800(600)	727			382	Base unit supplied with two cut-back legs 800mm or 600mm deep.
2012(-6)	1800	800(600)	727			403	
3012(-6)	1800	800(600)	727			403	
4012	1800	800	727			403	
5012(-6)	1800	800(600)	727			403	
1015(-6)	1600	1200	727			515	Base unit radial workstation with cut-back leg. Specify LH or RH. (RH shown) 800mm units (1015) to have a 800mm end and a 600mm return end. 600mm units (1015-6) to have two 600mm ends.
2015(-6)	1600	1200	727			537	
3015(-6)	1600	1200	727			537	
4015	1600	1200	727			537	
5015(-6)	1600	1200	727			537	
1016(-6)	1800	1200	727			572	Base unit radial workstation with cut-back leg. Specify LH or RH. (RH shown) 800mm units (1016) to have a 800mm end and a 600mm return end. 600mm units (1016-6) to have two 600mm ends.
2016(-6)	1800	1200	727			592	
3016(-6)	1800	1200	727			592	
4016	1800	1200	727			592	
5016(-6)	1800	1200	727			592	
1017(-6)	800	800(600)	727			481	Base corner unit @ 90° with 800mm radius, cut-back legs and 800mm or 600mm deep.
2017(-6)	800	800(600)	727			502	
3017(-6)	800	800(600)	727			502	
5017(-6)	800	800(600)	727			502	
1018(-6)	1700	800(600)	727			622	Base corner unit @ 90° with 1200mm radius, cut-back legs and 800mm or 600mm deep.
2018(-6)	1700	800(600)	727			643	
3018(-6)	1700	800(600)	727			643	
5018(-6)	1700	800(600)	727			643	
1073	1000	800(600)	727			339	Wave base unit with two cut back legs. Specify LH or RH (RH shown)
2073	1000	800(600)	727			347	
3073	1000	800(600)	727			347	
5073	1000	800(600)	727			347	

## BASE UNITS - 2 CUT-BACK LEGS

### CODE: (1)000

Base unit only, without top unit or shelves.

### CODE: (2)000

Base unit to accommodate top unit.

### CODE: (3)000

Base unit to accommodate a shaped MFC or glass shelf on steel supports.

### CODE: (4)000

Base unit 1200(W), 1400(W), 1600(W), and 1800(W) to accommodate mobile rotating shelf unit.

Description	Code	W	x	D	x	H	Price £
-------------	------	---	---	---	---	---	---------

Base corner unit @ 45° with 800mm radius, cut-back legs 800mm or 600mm deep.

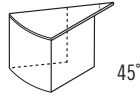

1019(-6)	610	800(600)	727	<b>382</b>
2019(-6)	610	800(600)	727	<b>403</b>

Base corner unit @ 45° with 1200mm radius, cut-back legs 800mm or 600mm deep.



1020(-6)	920	800(600)	727	<b>495</b>
2020(-6)	920	800(600)	727	<b>515</b>

Base corner unit with 1200mm radius inverted with cut-back legs, centre leg 800mm or 600mm deep.



1021(-6)	1700	800(600)	727	<b>643</b>
2021(-6)	1700	800(600)	727	<b>664</b>
3021(-6)	1700	800(600)	727	<b>664</b>
5021(-6)	1700	800(600)	727	<b>664</b>

Base unit with horizontal and vertical hatch doors and latch. Two full P-End legs 800mm or 600mm deep.

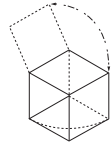

1022	800	800	727	<b>333</b>
1022(-6)	600	600	727	<b>333</b>
1022(-86)	800	600	727	<b>333</b>

Radius base unit @ 60° with two cut back legs 800mm or 600mm deep.

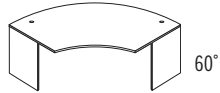

1061(-6)	1800	800(600)	727	<b>715</b>
2061(-6)	1800	800(600)	727	<b>739</b>
3061(-6)	1800	800(600)	727	<b>739</b>
5061(-6)	1800	800(600)	727	<b>739</b>

Radius base unit INVERTED @ 60° with two cut back legs 800mm or 600mm deep.

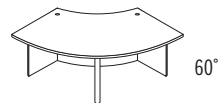

1062(-6)	1800	800(600)	727	<b>737</b>
2062(-6)	1800	800(600)	727	<b>762</b>
3062(-6)	1800	800(600)	727	<b>762</b>
5062(-6)	1800	800(600)	727	<b>762</b>

Base segment unit @ 30° with two cut back legs 800mm or 600mm deep.



1063(-6)	880	800(600)	727	<b>465</b>
2063(-6)	880	800(600)	727	<b>484</b>

Base segment unit INVERTED @ 30° with two cut back legs 800mm or 600mm deep.

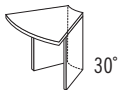

1064(-6)	880	800(600)	727	<b>479</b>
2064(-6)	880	800(600)	727	<b>500</b>

Radius base unit @ 45° with two cut back legs 800mm or 600mm deep.

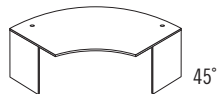

1065(-6)	1530	800(600)	727	<b>591</b>
2065(-6)	1530	800(600)	727	<b>611</b>
3065(-6)	1530	800(600)	727	<b>611</b>
5065(-6)	1530	800(600)	727	<b>611</b>

Radius base unit INVERTED @ 45° with two cut back legs 800mm or 600mm deep.

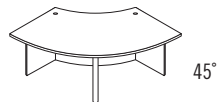

1066(-6)	1530	800(600)	727	<b>680</b>
2066(-6)	1530	800(600)	727	<b>702</b>
3066(-6)	1530	800(600)	727	<b>702</b>
5066(-6)	1530	800(600)	727	<b>702</b>

Base segment unit @ 22° with two cut back legs 800mm or 600mm deep.



1067(-6)	780	800(600)	727	<b>450</b>
2067(-6)	780	800(600)	727	<b>471</b>

Base segment unit INVERTED @ 22° with two cut back legs 800mm or 600mm deep.

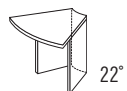

1068(-6)	780	800(600)	727	<b>465</b>
2068(-6)	780	800(600)	727	<b>484</b>

**CODE: (5)000**

Base unit to accommodate an executive glass shelf on brushed steel supports.

**BASE UNITS - TWO FULL P-END LEGS**

Code	W	x	D	x	H	Price £
1030(-6)	800	800(600)	727			297
2030(-6)	800	800(600)	727			319
3030(-6)	800	800(600)	727			319
5030(-6)	800	800(600)	727			319
1031(-6)	1000	800(600)	727			311
2031(-6)	1000	800(600)	727			333
3031(-6)	1000	800(600)	727			333
5031(-6)	1000	800(600)	727			333
1032(-6)	1200	800(600)	727			326
2032(-6)	1200	800(600)	727			347
3032(-6)	1200	800(600)	727			347
4032	1200	800	727			347
5032(-6)	1200	800(600)	727			347
1033(-6)	1400	800(600)	727			339
2033(-6)	1400	800(600)	727			361
3033(-6)	1400	800(600)	727			361
4033	1400	800	727			361
5033(-6)	1400	800(600)	727			361
1034(-6)	1600	800(600)	727			361
2034(-6)	1600	800(600)	727			382
3034(-6)	1600	800(600)	727			382
4034	1600	800	727			382
5034(-6)	1600	800(600)	727			382
1035(-6)	1800	800(600)	727			382
2035(-6)	1800	800(600)	727			403
3035(-6)	1800	800(600)	727			403
4035	1800	800	727			403
5035(-6)	1800	800(600)	727			403
1013(-6)	1600	1200	727			515
2013(-6)	1600	1200	727			537
3013(-6)	1600	1200	727			537
4013	1600	1200	727			537
5013(-6)	1600	1200	727			537
1014(-6)	1800	1200	727			572
2014(-6)	1800	1200	727			592
3014(-6)	1800	1200	727			592
4014	1800	1200	727			592
5014(-6)	1800	1200	727			592
1069(-6)	1800	800(600)	727			715
2069(-6)	1800	800(600)	727			739
3069(-6)	1800	800(600)	727			739
5069(-6)	1800	800(600)	727			739
1070(-6)	1800	800(600)	727			737
2070(-6)	1800	800(600)	727			762
3070(-6)	1800	800(600)	727			762
5070(-6)	1800	800(600)	727			762
1071(-6)	1530	800(600)	727			591
2071(-6)	1530	800(600)	727			611
3071(-6)	1530	800(600)	727			611
5071(-6)	1530	800(600)	727			611
1072(-6)	1530	800(600)	727			680
2072(-6)	1530	800(600)	727			702
3072(-6)	1530	800(600)	727			702
5072(-6)	1530	800(600)	727			702

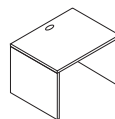

Base unit supplied with two full panel end legs 800mm or 600mm deep.

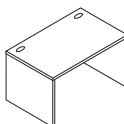

Base unit supplied with two full panel end legs 800mm or 600mm deep.

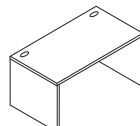

Base unit supplied with two full panel end legs 800mm or 600mm deep.

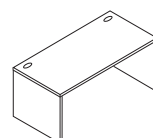

Base unit supplied with two full panel end legs 800mm or 600mm deep.

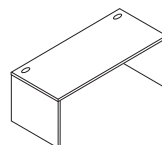

Base unit supplied with two full panel end legs 800mm or 600mm deep.

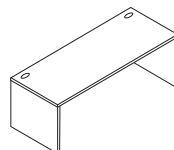

Base unit supplied with two full panel end legs 800mm or 600mm deep.

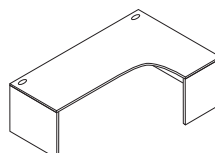

Base unit radial workstation with full panel end legs, please specify LH or RH. (RH shown) 800mm units (1013) to have one 800mm end and a 600mm return end. 600mm units (1013-6) to have two 600mm ends.

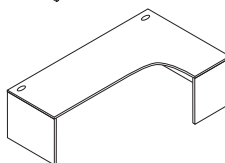

Base unit radial workstation with full panel end legs, please specify LH or RH. (RH shown) 800mm units (1014-6) to have one 800mm end and a 600mm return end. 600mm units (1014-6) to have two 600mm ends.

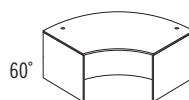

Radius base unit @ 60° with two full panel end legs 800mm or 600mm deep.

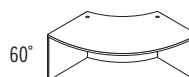

Radius base unit inverted @ 60° with two full panel end legs 800mm or 600mm deep.

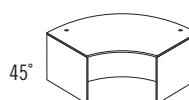

Radius base unit @ 45° with two full panel end legs 800mm or 600mm deep.



Radius base unit inverted @ 45° with two full panel end legs 800mm or 600mm deep.



**BASE UNITS -  
WITH RECESS FOR WHEEL CHAIR ACCESS**

Description

Code

W x D x H

Price £

Base unit supplied with two full panel end legs and recessed mod panel (recessed 400mm)

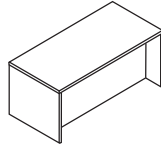

1040

1600 800 727

339

Base unit radial workstation with full panel end legs and recessed mod panel. Please specify LH or RH. (LH shown) (recessed 400mm)

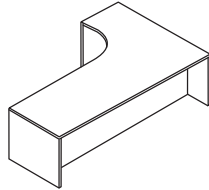

1041

1800 1200 727

572

Base unit supplied with one cut back leg and recessed mod panel. (RH shown) (recessed 400mm)

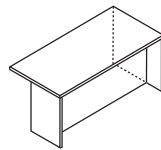

1042

1600 800 727

339

Base unit radial workstation with one cut-back leg and recessed mod panel. Please specify LH or RH. (LH shown) (recessed 400mm)

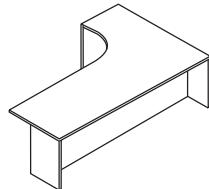

1043

1800 1200 727

572

Base unit supplied with two cut-back legs and recessed mod panel. (recessed 400mm)

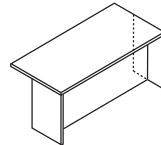

1044

1600 800 727

339

Base corner unit @ 90° with 1200mm radius, with two cut-back legs and recessed mod panel. (recessed 400mm)

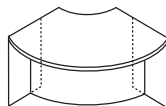

1045

1200 1200 727

622

Base corner unit @ 90° with 1200mm radius, with one cut-back leg and recessed mod panel. Specify LH or RH. LH shown.

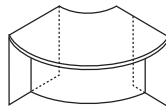

1046

1200 1200 727

622

Conference link with 300mm base.



1050(-6)

1000(800) 800(600) 727

426

Cutback base units are not 'STAND ALONE' units and must be anchored to other base units on 'CUT-BACK SIDE' for stability.

Code	W	x	D	x	H	Price £	Description
1101	800	x	350	x	465	198	Top unit for reception base units.
1102	1000	x	350	x	465	213	Top unit for reception base units.
1103	1200	x	350	x	465	226	Top unit for reception base units.
1104	1400	x	350	x	465	240	Top unit for reception base units.
1105	1600	x	350	x	465	256	Top unit for reception base units.
1106	1800	x	350	x	465	275	Top unit for reception base units.
1107	800	x	350	x	465	220	Top unit with wave cut-back for reception base unit. Please specify RH or LH. Cut back depth is 180mm. (RH shown)
1108	1000	x	350	x	465	235	Top unit with wave cut-back for reception base unit. Please specify RH or LH. Cut back depth is 180mm. (RH shown)

TOP UNITS

Description

Code

W x D x H

Price £

Top unit with wave cut-back for reception base unit. Please specify RH or LH. Cut back depth is 180mm. (RH shown)

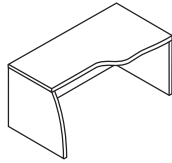

1109

1200 350 465

248

Top unit with wave cut-back for reception base unit. Please specify RH or LH. Cut back depth is 180mm (RH shown)

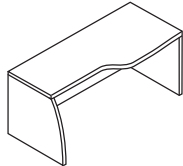

1110

1400 350 465

262

Top unit with wave cut-back for reception base unit. Please specify RH or LH. Cut back depth is 180mm (RH shown)

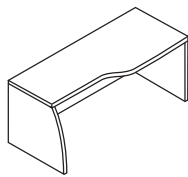

1111

1600 350 465

275

Top unit with wave cut-back for reception base unit. Please specify RH or LH. Cut back depth is 180mm (RH shown)

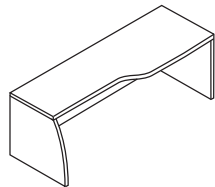

1112

1800 350 465

297

Top unit @ 90° with 800mm radius, 350mm deep. No accessories can be fitted.

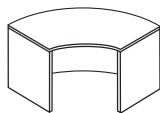

1113

800 800 465

275

Top unit @ 90° with 1200mm radius, 350mm deep. No accessories can be fitted.

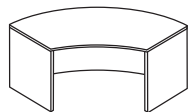

1114

1200 1200 465

333

Top unit @ 90° with 800mm radius 180mm deep. Compatible with all wave cut-back top units. No accessories can be fitted.

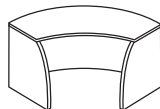

1115

800 800 465

220



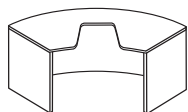

Top unit @ 90° 1200mm radius, 350mm deep with cut-out. No accessories can be fitted.

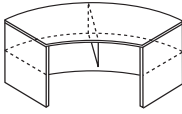
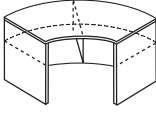
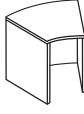

1116

1200 1200 465

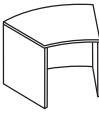
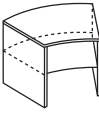
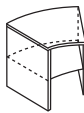
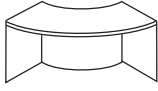
361

Code	W	x	D	x	H	Price £	Description
1117	1200		1200		465	416	 <p>Top unit @ 90°, 1200mm radius with shelf, 350mm deep. No accessories can be fitted.</p>
1118	800		800		465	347	 <p>Top unit @ 90°, 800mm radius with shelf, 350mm deep. No accessories can be fitted.</p>
1119	612		350		465	220	 <p>Top unit @ 45° with 800mm radius, 350mm deep. No accessories can be fitted.</p>
1120	612		180		465	178	 <p>Top unit @ 45° with 800mm radius, 180mm deep. Compatible with all wave cut-back top units. No accessories can be fitted.</p>
1121	918		180		465	270	 <p>Top unit @ 45° with 1200mm radius, 180mm deep. Compatible with all wave cut-back top units. No accessories can be fitted.</p>
1122	918		350		465	220	 <p>Top unit @ 45° with 1200mm radius, 350mm deep. No accessories can be fitted.</p>
1123	918		350		465	333	 <p>Top unit @ 45°, 1200mm radius with shelf, 350mm deep. No accessories can be fitted.</p>
1124	612		350		465	275	 <p>Top unit @ 45°, 800mm radius with shelf, 350mm deep. No accessories can be fitted.</p>
1125	1061		350		465	275	 <p>Top unit @ 90° 350mm deep INVERTED. No accessories can be fitted.</p>
1139	820		180		465	325	 <p>Top unit @ 90° 180mm deep INVERTED. No accessories can be fitted.</p>

TOP UNITS

Description Code W x D x H Price £

Top unit @ 60°  
No accessories can be fitted.



1140 1800 350 465 382

Top unit @ 60° with fixed shelf.  
No accessories can be fitted.

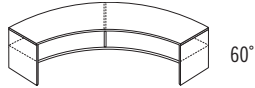

1141 1800 350 465 478

Top unit @ 60° INVERTED.  
No accessories can be fitted.



1142 1800 350 465 317

Top unit @ 60° INVERTED  
with fixed shelf.  
No accessories can be fitted.

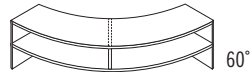

1143 1800 350 465 395

Top unit segment @ 30°  
No accessories can be fitted.

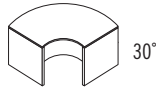

1144 880 350 465 220

Top unit segment @ 30° INVERTED.  
No accessories can be fitted.



1145 880 350 465 255

Top unit @ 45°  
No accessories can be fitted



1146 1530 350 465 363

Top unit @ 45° with fixed shelf.  
No accessories can be fitted.

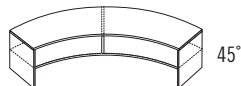

1147 1530 350 465 345

Top unit @ 45°INVERTED.  
No accessories can be fitted

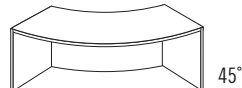

1148 1530 350 465 302

Top unit @ 45°INVERTED  
with fixed shelf.  
No accessories can be fitted.

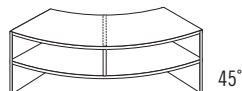

1149 1530 350 465 377

Top unit segment @ 22°  
No accessories can be fitted.





1150 780 350 465 215

Top unit segment @ 22°INVERTED.  
No accessories can be fitted.

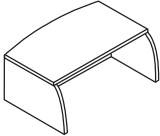
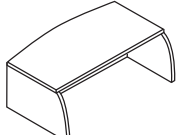
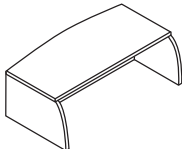
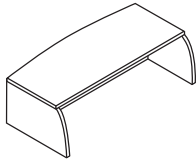
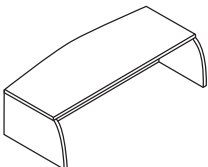
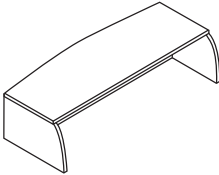

1151 780 350 465 248

Code	W	x	D	x	H	Price £	Description
1131	800		420		230	198	 <p>Shallow top units for reception base units. No accessories can be fitted.</p>
1132	1000		420		230	213	 <p>Shallow top units for reception base units. No accessories can be fitted.</p>
1133	1200		420		230	226	 <p>Shallow top units for reception base units. No accessories can be fitted.</p>
1134	1400		420		230	240	 <p>Shallow top units for reception base units. No accessories can be fitted.</p>
1135	1600		420		230	256	 <p>Shallow top units for reception base units. No accessories can be fitted.</p>
1136	1800		420		230	275	 <p>Shallow top units for reception base units. No accessories can be fitted.</p>
1137	800		880		230	275	 <p>Shallow top units @ 90° with 800mm radius, 420mm deep. No accessories can be fitted.</p>
1138	1200		1200		230	333	 <p>Shallow top units @ 90° with 1200mm radius, 420mm deep. No accessories can be fitted.</p>

SHAPED MFC OR GLASS SHELVES

Description

Code

W x D x H

Price £

Fixed bowed reception shelf (silver) MFC or glass, clear or frosted on steel supports.



for 800mm base unit and 1200mm radius inverted base unit (3021)

1301 (S)	600	300	225	157
1301 (C)	600	300	225	472
1301 (F)	600	300	225	472

Fixed bowed reception shelf (silver) MFC or glass, clear or frosted on steel supports.



for 1000mm base unit and 45° inverted radius base unit (3058/3066/3072)

1302 (S)	800	300	225	170
1302 (C)	800	300	225	489
1302 (F)	800	300	225	489

Fixed bowed reception shelf (silver) MFC or glass, clear or frosted on steel supports.



for 1200mm base unit and 60° inverted radius base unit (3054/3062/3070)

1303 (S)	900	300	225	178
1303 (C)	900	300	225	506
1303 (F)	900	300	225	506

Fixed bowed reception shelf (silver) MFC or glass, clear or frosted on steel supports.



(for 1400mm base unit)

1304 (S)	1000	300	225	185
1304 (C)	1000	300	225	523
1304 (F)	1000	300	225	523

Fixed bowed reception shelf (silver) MFC or glass, clear or frosted on steel supports.



for 1600mm base unit and 45° radius base unit (3057/3065/3071)

1305 (S)	1200	300	225	198
1305 (C)	1200	300	225	540
1305 (F)	1200	300	225	540

Fixed bowed reception shelf (silver) MFC or glass, clear or frosted on steel supports.



for 1800mm base unit and 60° radius base unit (3053/3061/3069)

1306 (S)	1400	300	225	213
1306 (C)	1400	300	225	581
1306 (F)	1400	300	225	581

Fixed 90° corner reception shelf (silver) MFC or glass, clear or frosted on steel supports.



(for 800mm corner units)

1307 (S)	800	800	225	198
1307 (C)	800	800	225	540
1307 (F)	800	800	225	540

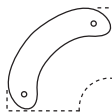

Fixed 90° corner reception shelf (silver) MFC or glass, clear or frosted on steel supports.



(for 1200mm corner units)

1308 (S)	1200	1200	225	226
1308 (C)	1200	1200	225	752
1308 (F)	1200	1200	225	752

(S) = Silver (C) = Clear (F) = Frosted

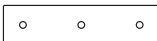
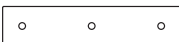
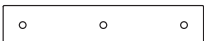
Code	W	x	D	x	H	Price £	Description
1501 (C)	796	350	210			473	 <p>800mm Rectangular Glass Shelf to suit 800mm base unit                      5001 (-6) - with 1 cut back leg                      5007 (-6) - with 2 cut back legs                      5030 (-6) - with 2 full legs</p>
1501 (F)	796	350	210			473	
1502 (C)	996	350	210			489	 <p>1000mm Rectangular Glass Shelf to suit 1000mm base unit                      5002 (-6) - with 1 cut back leg                      5008 (-6) - with 2 cut back legs                      5031 (-6) - with 2 full legs                      5073 (-6) - with 2 cut back legs</p>
1502 (F)	996	350	210			489	
1503 (C)	1196	350	210			504	 <p>1200mm Rectangular Glass Shelf to suit 1200mm base unit                      5003 (-6) - with 1 cut back leg                      5009 (-6) - with 2 cut back legs                      5032 (-6) - with 2 full legs</p>
1503 (F)	1196	350	210			504	
1504 (C)	1396	350	210			522	 <p>1400mm Rectangular Glass Shelf to suit 1400mm base unit                      5004 (-6) - with 1 cut back leg                      5010 (-6) - with 2 cut back legs                      5033 (-6) - with 2 full legs</p>
1504 (F)	1396	350	210			522	
1505 (C)	1596	350	210			541	 <p>1600mm Rectangular Glass Shelf to suit 1600mm base unit                      5005 (-6) - with 1 cut back leg                      5011 (-6) - with 2 cut back legs                      5034 (-6) - with 2 full legs                      5013 (-6) - radial with full legs                      5015 (-6) - radial with 1 cut back leg</p>
1505 (F)	1596	350	210			541	
1506 (C)	1796	350	210			580	 <p>1800mm Rectangular Glass Shelf to suit 1800mm base unit                      5006 (-6) - with 1 cut back leg                      5012 (-6) - with 2 cut back legs                      5035 (-6) - with 2 full legs                      5014 (-6) - radial with full legs                      5016 (-6) - radial with 1 cut back leg</p>
1506 (F)	1796	350	210			580	

GLASS SHELVES & MOBILE SHELVES

Description

Code

W x D x H

Price £

90 Deg 800 Rad Glass to suit  
90 Deg base unit  
5017-(6) - with 2 cut back legs  
5051-(6) - with 1 cut back leg



1507 (C)	1120	476	210	541
1507 (F)	1120	476	210	541

90 Deg 1200 Rad Glass to suit  
1200mm Rad 90 Deg base unit  
5018-(6) - with 2 cut back legs  
5052-(6) - with 1 cut back leg



1508 (C)	1686	593	210	751
1508 (F)	1686	593	210	751

90 Deg Inverted 800 Rad Glass to suit  
800mm Rad 90 Deg Inverted base unit  
5021-(6) - with 2 cut back legs



1509 (C)	1049	462	210	541
1509 (F)	1049	462	210	541

60 Deg Glass to suit 60 Deg base unit  
5053-(6) - with 1 cut back leg  
5061-(6) - with 2 cut back legs  
5069-(6) - with 2 full legs



1510 (C)	1789	543	210	751
1510 (F)	1789	543	210	751

60 Deg Inverted Glass to suit  
60 Deg Inverted base unit  
5054-(6) - with 1 cut back leg  
5062-(6) - with 2 cut back legs  
5070-(6) - with 2 full legs

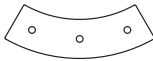

1511 (C)	1339	479	210	594
1511 (F)	1339	479	210	594

45 Deg Glass to suit 45 Deg base unit  
5057-(6) - with 1 cut back leg  
5065-(6) - with 2 cut back legs  
5071-(6) - with 2 full legs



1512 (C)	1521	472	210	615
1512 (F)	1521	472	210	615

45 Deg Inverted Glass to suit  
45 Deg Inverted base unit  
5058-(6) - with 1 cut back leg  
5066-(6) - with 2 cut back legs  
5072-(6) - with 2 full legs



1513 (C)	1176	438	210	541
1513 (F)	1176	438	210	541

Mobile rotating shelf unit (silver) on  
steel support incorporating tubular  
leg and castor.



(for 1200mm BU, L/H shown)

1401	1065	540	954	206
------	------	-----	-----	-----

Mobile rotating shelf unit (silver) on  
steel support incorporating tubular  
leg and castor.



(for 1400mm BU, L/H shown)

1402	1275	590	954	220
------	------	-----	-----	-----

Mobile rotating shelf  
unit (silver) on steel  
support incorporating  
tubular leg and castor.



(for 1600mm BU, L/H shown)

1403	1465	640	954	235
------	------	-----	-----	-----

Mobile rotating shelf  
unit (silver) on steel  
support incorporating  
tubular leg and castor.



(for 1800mm BU, L/H shown)

1404	1665	685	954	248
------	------	-----	-----	-----

Code	W	x	D	x	H	Price £	Description
1201	556	160	216			85	160mm deep <b>shelf unit</b> to fit inside top-unit.
1202	556	320	216			114	320mm deep <b>shelf unit</b> to fit inside top-unit.
1203	556	320	216			150	<b>Tray unit</b> with 4 pull-out trays to fit inside top-unit.
1204	556	160	168			114	<b>CD-unit</b> to fit inside top-unit.
1205	556	160	216			150	<b>Key-unit</b> to fit inside top-unit (18 hooks-lockable).
1210	465	575	690			275	Mobile storage unit to slide under base unit (with one adjustable shelf). (R/H shown)
1211	405	600	727			344	Desk height pedestal 36 with back to match receptiv base units.
2211	405	600	727			382	
1213	405	800	727			396	Desk height pedestal 38 with back to match receptiv base units.
2213	405	800	727			442	
1214	405	350	465			171	Top unit for receptiv desk height pedestal units (pedestal not included).
EMP 25	423	500	568			183	Mobile pedestal for 600 deep base units.
EMP 35	423	500	568			183	
XP-M3M	400	575	580			259	Mobile metal pedestal 3 drawer and heavy duty in silver Ral 9006 includes pen tray.

## RECEPTION TABLES

Description

Code

W x D x H

Price £

Circular table with tapered silver legs.



5101

550 550 400

262

Circular table with curtain leg.



5201

550 550 400

275

Elliptical table with tapered silver legs.



5102

1000 500 400

297

Elliptical table with curtain leg.



5202

1000 500 400

311

Square table with tapered silver legs.



5103

550 550 400

275

Square table with curtain leg.



5203

550 550 400

291

Kidney table with tapered silver legs.



5104

1020 570 400

305

Kidney table with curtain leg.



5204

1020 570 400

319

Triangular table with tapered silver legs.



5105

635 635 400

275

Triangular table with curtain leg.



5205

635 635 400

291

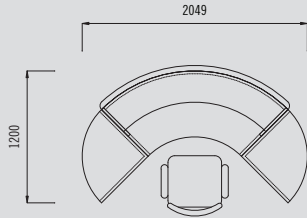

**ALTERNATIVE 1 - 600MM DEEP**

The new 600mm deep base units give us the opportunity to provide far more compact and space saving reception layouts.

This in turn makes our Receptiv Range more flexible and accommodating to virtually any requirements without having to pay for specially made receptions.

This option shows a wide radius segment base unit with radial storage units at either side. The base unit hosts a shallow top unit that also acts as a shelf.

**PRODUCTS USED:** 1 x 2018-6, 1 x 1138 & 2 x ERE6

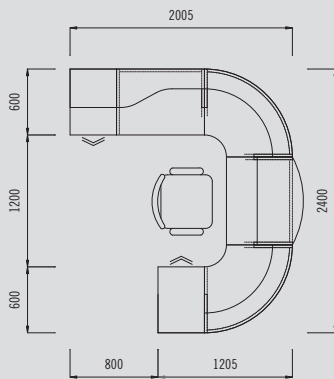

**ALTERNATIVE 2 - 600MM DEEP**

Even with a large footprint 'look' it is surprising that this proposal only requires a space of 2.4 x 2.005m excluding flow-space around the units.

This is a mere 4.43sqm and even with such a compact size, it offers all of Receptiv's grandeur, style and functionality.

New to this range is also a Desk Height Pedestal with the same depth of the base units as well as having adopted the same construction and look, for it to merge into the configuration unnoticed.

**PRODUCTS USED:** 1 x 2211, 1 x 2001-6, 1 x 2007-6, 1 x 2017-6, 1 x 2051-6, 1 x 1211, 2 x 1115, 1 x 1131, 1 x 1107 & 1 x 1214

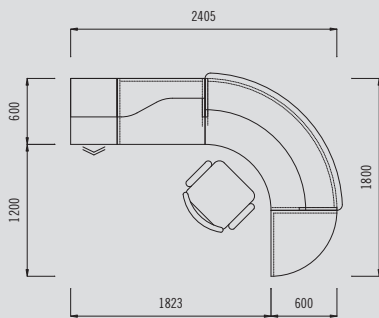

**ALTERNATIVE 3 - 600MM DEEP**

Here we have an L-Shape formation which is a very popular layout with the 800 deep base units with it requiring even less floor space.

Not only is the Desk Height Pedestal a base unit, but it can also accommodate a top unit to continue Receptiv's flowing lines.

A waved top unit creates a little flair to the overall look together with a shallow top unit that allows for good sight lines as well as storage space for the unsightly items.

**PRODUCTS USED:** 1 x 2211, 1 x 2001-6, 1 x 2052-6, 1 x 1138, 1 x 1107, 1 x 1214 & 1 x ERE6

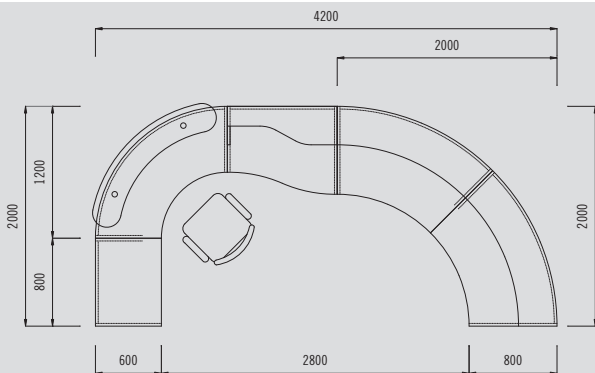

**ALTERNATIVE 4 - 600MM DEEP**

Now that we have both an 800 and 600 deep base unit option, we have given Receptiv the opportunity to migrate from a 800 deep configuration to a 600 deep configuration, all in one layout.

Naturally there are many other configurations available but this layout merely shows you how one can change from 800 to 600 deep base units (vice versa) with ease.

A clear or frosted glass shelf on the radius base unit allows Receptiv to have a more corporate, luxurious feel.

**PRODUCTS USED:** 1 x 2001-6, 1 x 3018-6, 1 x 2073, 1 x 2065-6, 1 x 2057-6, 1 x 1147, 1 x 1146, 1 x 1108 & 1 x 1308

**ALTERNATIVE 1**

Receptiv's 800 deep base and top units are already extensive in its entirety but we have yet added more options to make configurations more accommodating than before.

On this layout we have the new radius segment base unit which has a far more shallow inner radius for comfort and practicality. Flanked on either side of this unit we have the new segment base units and together this configuration makes up a useful 90° layout which fits perfectly into the corner of a room.

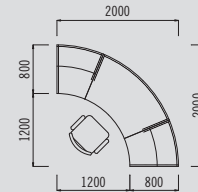

**PRODUCTS USED:** 2 x 1150, 2 x 2059 & 1 x 1065

**ALTERNATIVE 2**

This layout shows off alternate configurations of the different radius units which can create a nice sweeping, creative flow of the reception outline.

These radius units come in a variety of angled ends starting with the original 90° option, then a 45°, 22°, 60° and 30° option. These alternatives give our CAD department more freedom for their space planning and designs. These options don't only apply to the base units but also include the top units

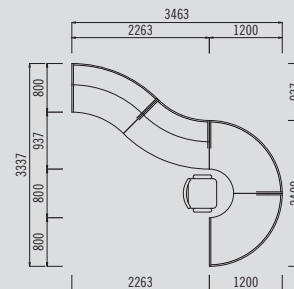

**PRODUCTS USED:** 1 x 2057, 1 x 1147, 1 x 2066, 1 x 1148, 1 x 1018 & 1 x 1052

**ALTERNATIVE 3**

Another effective layout that fits nicely into a corner of a foyer or room. Even though these are 800 deep units with more working space surface, it is yet small and compact enough to fit into a 6.6m<sup>2</sup> floor area without difficulty.

Cut-back panel-end legs of the central units allow for free-flow leg room and offers a more user friendly working environment. Optional extras such as top units or shelves can be added to these base units.

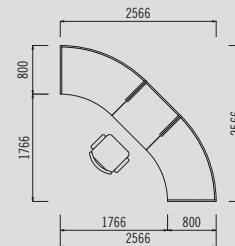

**PRODUCTS USED:** 2 x 1057 & 1 x 1007

**ALTERNATIVE 4**

This compact yet stylish layout is created with both 90° and 45° base units. The central base unit offers a nice glass shelf option and the two units on either side offer the full height top units, ideal for concealing office stationary and creating a secure, private environment.

This layout is ideal for a central position of an entrance foyer. Note that, making use of different finishes to base and top units can create interesting visual appearances. We have a large library of finishes to choose from.

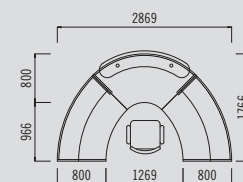

**PRODUCTS USED:** 2 x 2057, 2 x 1147, 1 x 3018 & 1 x 1308

**ALTERNATIVE 5**

Here we have a central base unit which allows for wheelchair access and is compliant with the DDA requirements. On either side of this unit we have both the 22° and 22° inverted segment base units which create a shallow curved flow.

This configuration could perhaps fit into a wall opening of a corridor. Good stability of the individual base units is created by securing all base legs to one another with special securing bolts which are all provided in the kit.

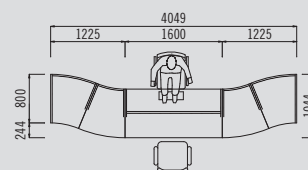

**PRODUCTS USED:** 2x 1059, 2 x 1068 & 1 x 1044

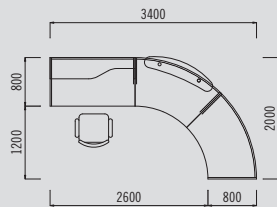
**ALTERNATIVE 6**

Here we have an L-Shape formation which is a very sought after layout and now possible with the addition of the new radius segments with their different angled ends. These radius segment units provide a more gentle curve.

A waved top unit creates a little flair to the overall look together with a shelf unit, whether frosted, clear glass or MFC board. Full panel ends to curved units are standard and no longer need to be specially ordered.

**PRODUCTS USED:** 1 x 1057, 1 x 3065, 1 x 1305, 1 x 2004 & 1 x 1110

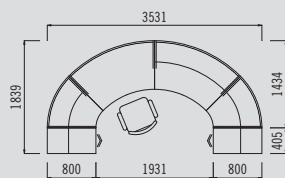
**ALTERNATIVE 7**

A balanced layout provides working space for one or two people. Two 45° radius base units, one with and one without a top unit offer a grand frontage.

Two 45° segment base units balance the reception out to 180° configuration. This is completed with two desk height pedestal base units each housing 2 shallow & 1 filling drawer. Top units to the pedestals are optional.

**PRODUCTS USED:** 2 x 2213, 2 x 1214, 2 x 2020, 2 x 1122, 1 x 1065, 1 x 2065 & 1 x 1146

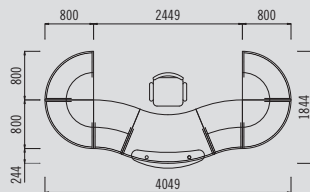
**ALTERNATIVE 8**

This curvaceous, luxurious balanced configurations with the centrally placed shallow radius base unit that accommodates a stylish glass shelf unit for signing documents in a comfortable standing position flanked with segment and 90 base units that include top units for privacy.

Combining your finishes of your base and top units to create that added touch. Altogether an impressive display when entering the foyer of a corporate company.

**PRODUCTS USED:** 2 x 2051, 2 x 2017, 2 x 2068, 1 x 3065, 1 x 1305, 2 x 1151 & 4 x 1118

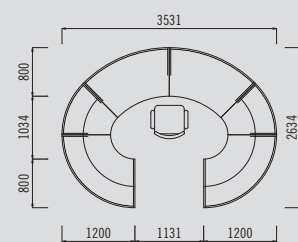
**ALTERNATIVE 9**

Almost elliptical in shape and virtually enclosed and yet allowing plenty of manoeuvrability and working space within the area.

This configuration is made up of two 45° radius segment base units flanked with two 45° segment and 90° corner units. All secured to one another they provide a solid uniform presence. By adding top units to the rear and sides offers more privacy. The larger radius top units come with a in situ shelf option.

**PRODUCTS USED:** 2 x 2052, 2 x 2020, 2 x 1065, 2 x 1122 & 2 x 1117

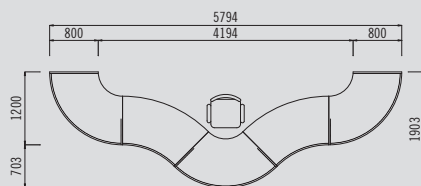
**ALTERNATIVE 10**

Today more emphasis is placed on curves and interesting shapes. Here we are merely showing you the effects that can be achieved with the variety of the new curved units, both standard and inverted.

The inverted base units are supported with one central steel leg for stability. Plenty of space under the base units allow for accessories such as mobile pedestals and storage units. Full panel end legs to curved units are standard and no longer need to be specially ordered.

**PRODUCTS USED:** 2 x 1052, 2 x 1066 & 1 x 1021

Please note that these 8 examples are merely a guide of many other variations possible, due to Receptiv's modular components. These names 'DON'T' refer to any particular 'FINISH' or 'SHAPE', but rather a point of reference.



semiflow

Code	Price	Quantity	Amount
2057	£611.00	2	£1222.00
5065	£611.00	2	£1222.00
1146	£363.00	2	£726.00
1512	£615.00	2	£1230.00
<b>Total Cost</b>			<b>£4,400.00</b>



freeflow

Code	Price	Quantity	Amount
2003	£347.00	1	£347.00
2017	£502.00	1	£502.00
2009	£347.00	1	£347.00
2018	£643.00	1	£643.00
2021	£664.00	1	£664.00
4004	£361.00	1	£361.00
1402	£220.00	1	£220.00
1125	£275.00	1	£275.00
1117	£416.00	1	£416.00
1103	£226.00	2	£452.00
1118	£347.00	1	£347.00
1203	£150.00	1	£150.00
<b>Total Cost</b>			<b>£4,724.00</b>



uniflow

Code	Price	Quantity	Amount
1101	£198.00	2	£396.00
2001	£319.00	2	£638.00
2017	£502.00	2	£1004.00
1118	£347.00	2	£694.00
3011	£382.00	1	£382.00
1305	£198.00	1	£198.00
1203	£150.00	1	£150.00
<b>Total Cost</b>			<b>£3,462.00</b>



multiflow

Code	Price	Quantity	Amount
2005	£382.00	1	£382.00
2018	£643.00	1	£643.00
2015	£537.00	2	£1074.00
3018	£643.00	1	£643.00
1308	£226.00	1	£226.00
1105	£256.00	2	£512.00
1116	£361.00	1	£361.00
1111	£275.00	1	£275.00
1050	£426.00	1	£426.00
1203	£150.00	1	£150.00
1204	£114.00	1	£114.00
<b>Total Cost</b>			<b>£4,806.00</b>



compact

Code	Price	Quantity	Amount
1117	£416.00	2	£832.00
1101	£198.00	3	£594.00
1114	£333.00	2	£666.00
2018	£643.00	4	£2,572.00
2007	£319.00	3	£957.00
1022	£333.00	1	£333.00
<b>Total Cost</b>			<b>£5,954.00</b>



contemporary

Code	Price	Quantity	Amount
2051-6	£502.00	2	£1004.00
2018-6	£643.00	1	£643.00
1115	£220.00	2	£440.00
1138	£333.00	1	£333.00
<b>Total Cost</b>			<b>£2,420.00</b>



segflow

Code	Price	Quantity	Amount
2057	£611.00	1	£611.00
3057	£611.00	1	£611.00
1213	£396.00	1	£396.00
1305-C	£540.00	1	£540.00
1146	£363.00	1	£363.00
<b>Total Cost</b>			<b>£2,518.00</b>



traditional

Code	Price	Quantity	Amount
2004	£361.00	2	£722.00
2011	£382.00	1	£382.00
2020	£515.00	2	£1030.00
3018	£643.00	1	£643.00
2021	£664.00	1	£664.00
1045	£622.00	1	£522.00
1110	£262.00	2	£524.00
1111	£275.00	1	£275.00
1121	£270.00	2	£540.00
1139	£325.00	1	£325.00
1210	£275.00	1	£275.00
1203	£150.00	1	£150.00
1204	£114.00	1	£114.00
1308-C	£752.00	1	£752.00
<b>Total Cost</b>			<b>£7018.00</b>

**Please Note:**

Due to Receptiv's modular components, please note that these examples & names are merely a reference guide of many other possible variations and 'DON'T' refer to any particular 'FINISH' or 'SHAPE'.

For your specific requirements, why not make use of our free CAD Planning service that will guarantee you the best option available. With our new 3D presentation software it is so much easier for you to visualise the finished product.

imperial

*Office furniture*

Imperial Office Furniture Ltd, Bankfield Business Park,  
Quebec Street, Bolton BL3 5JN  
Tel: 01204 364602 Fax: 01204 381509  
www.imperialfurniture.co.uk info@imperialfurniture.co.uk

**5 YEAR GUARANTEE**

Imperial Office Furniture is committed to providing  
exceptional service, manufacturing quality products  
with a comprehensive 5 year guarantee



**Bolton Business Environment Network**

Colours may vary slightly from those illustrated due to  
limitations of the printing process. E & OE.

J/N10876 Date 09/08